

## Application Note

### AN2001

#### D-Series

### Numeric digital display 500213

V 2.05

Please check [www.dimetix.com](http://www.dimetix.com)  
for the latest version

#### Abstract

This application shows how to display a measured distance value on a standard external numeric digital display. Description of the wiring and sensor configuration are included as well as two samples are given.

This application note is provided as is without any warranty for any problems this sample may cause.



## Table of content

1	Introduction .....	3
1.1	Requirements.....	3
2	Validation .....	3
3	Wiring .....	3
4	Sensor configuration .....	3
5	Simple application example 1 .....	3
5.1	Output protocol configuration.....	4
5.2	Measurements configuration.....	4
6	Advanced application example 2 .....	5
6.1	Output protocol configuration.....	6
6.2	Measurements configuration.....	6



# 1 Introduction

With the appropriate configuration of Dimetix sensors, numeric displays can be connected directly to the sensor without the need of any additional controller. This application note shows how to connect such a display and describes the required configuration steps. Two examples are provided as well.

## 1.1 Requirements

A computer with an USB or RS-232 Interface and our free "Laser Sensor Utility" software.

## 2 Validation

This application note is valid for the D-Series or newer sensors.

## 3 Wiring

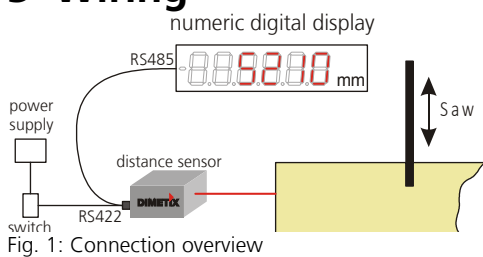

Fig. 1: Connection overview

Fig. 1 shows the connection of the components, while in Fig. 2 the detailed wiring diagram can be found.

Use a 6 pole shielded twisted pair cable to connect the display to the Sensor. 24V DC is used to power the display and the sensor. Take into account, that there is a significant voltage drop over the cable if the cable is long and the cross section is small.

The digital input DI1 (DO1 Pin) is connected to 24V DC via a 1k resistor. This signal ensures the start of the measurement as soon as power is applied. Measurement results are transmitted from the sensor to the numeric display.

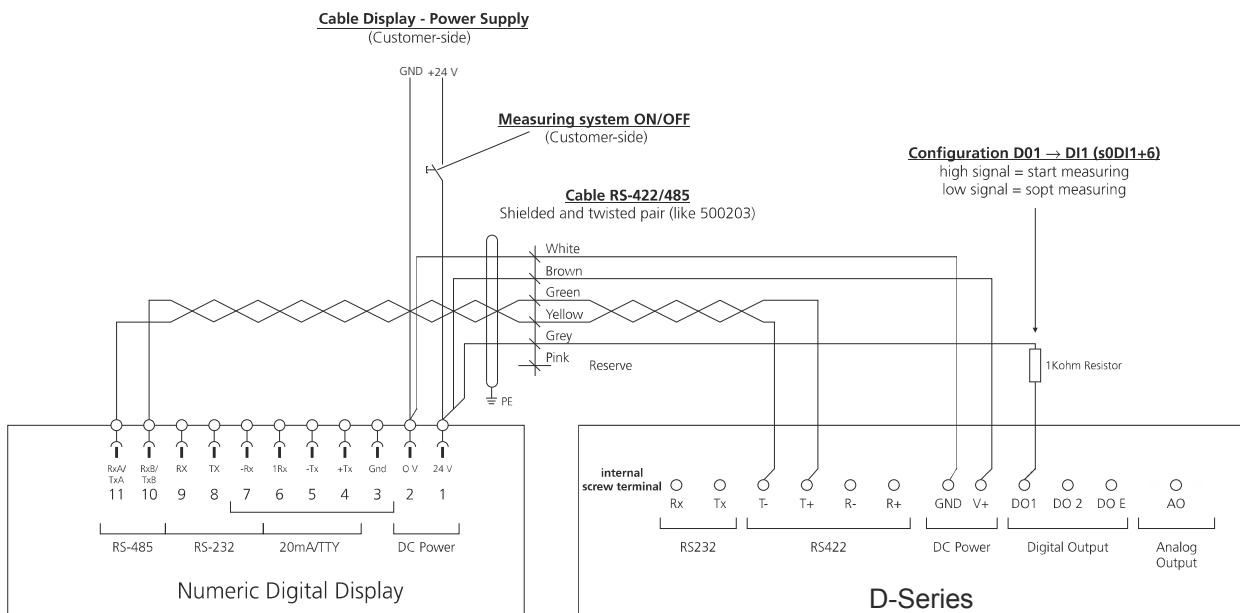

Fig. 2: Wiring diagram

## 4 Sensor configuration

The easiest way for an application specific sensor setting is to use our free "Laser Sensor Utility" software. The download is provided on our web page <https://dimetix.com/en/products/software/>. Connect the sensor to the USB or RS-232 interface of the PC as described in the sensor manual.

## 5 Simple application example 1

This is a simple application that directly shows the measured distance on the numeric digital display. No calculation with the measurement value are done before displaying it.

## 5.1 Output protocol configuration

This configures the displayed unit and the precision. In this sample the value is displayed in cm with a precision of mm.

Do the following steps with the Laser Sensor Utility SW

1. 'Connection' / 'Check Connection Button'
2. 'Configuration' / 'User output protocol' / Define the displayed value and the resolution

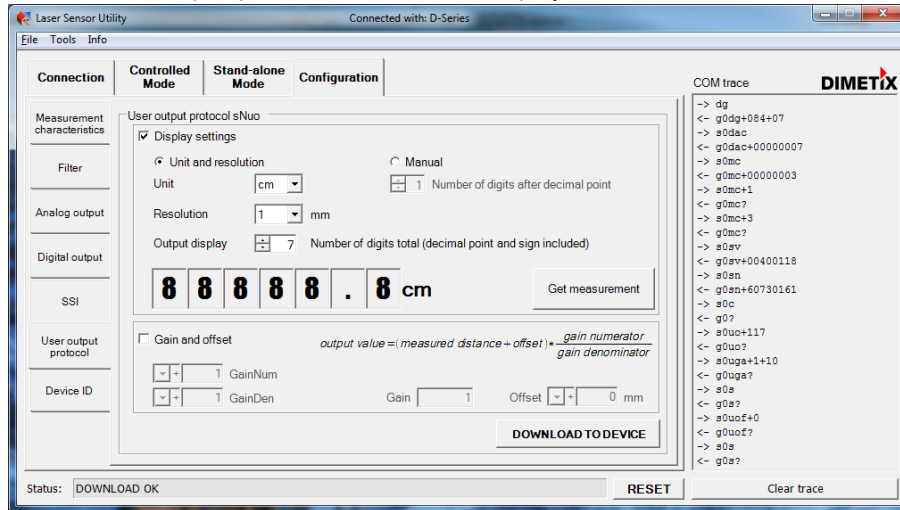

3. Press 'DOWNLOAD TO DEVICE' the configuration is stored into the device

## 5.2 Measurements configuration

There are two different possibilities to start a measurement.

### 5.2.1 Autostart with serial output

This works only if the interface board version is 1.17 or higher.

Do the following steps with the Laser Sensor Utility

1. 'Tools' / 'Manual command input'
2. Send the following commands: sNum+2, sNA+0

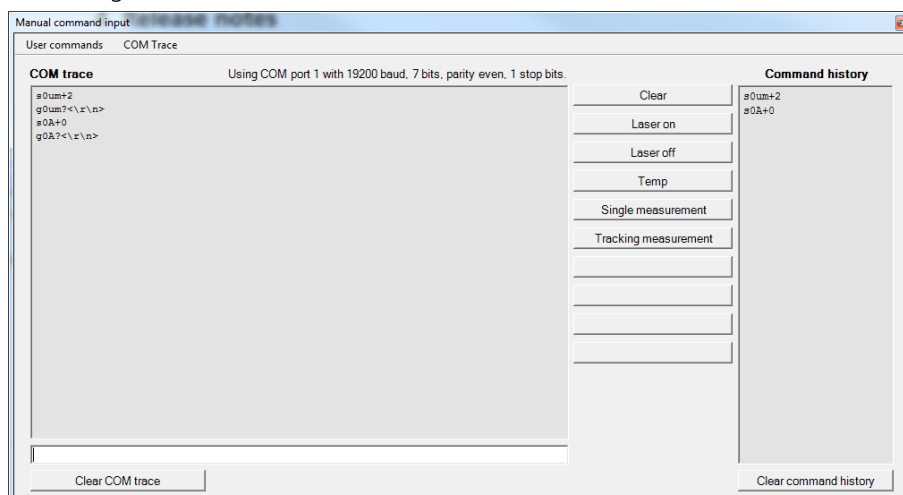

3. Do a power cycle on the sensor (Power off and on) and the system is running.

### 5.2.2 Measurement with digital input

Activates the digital input and configures it for auto start measurement after a power-on of the sensor.

Do the following steps with the DLS/FLS Utility SW

1. 'Stand-alone Mode' / 'Manual start configuration'
2. Select 'Active' and 'Start / Stop single sensor tracking'

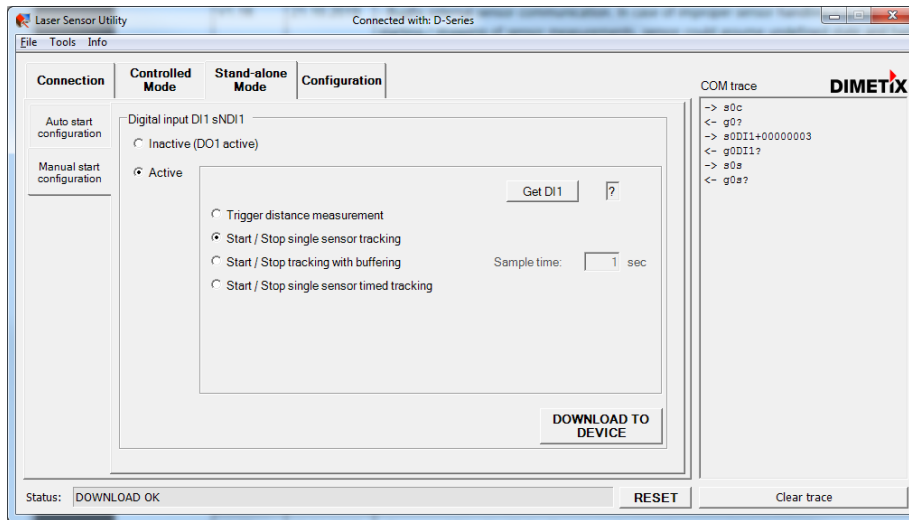

3. Press 'DOWNLOAD TO DEVICE' the configuration is stored into the device
4. Do a power cycle on the sensor (Power off and on) and the system is running (if digital input is active).

## 6 Advanced application example 2

Elements of different length must be cut by a saw. This application shows how to use the D-Series sensor together with an external display to show the millimeter precise length of the piece before it get cut.

Since the length of the cut-off piece can not be measured directly, some calculation have to be carried out before the length can be displayed. The D-Series sensor is able to do this calculations, hence no additional controller is necessary. This sample shows the necessary steps to configure the sensor.

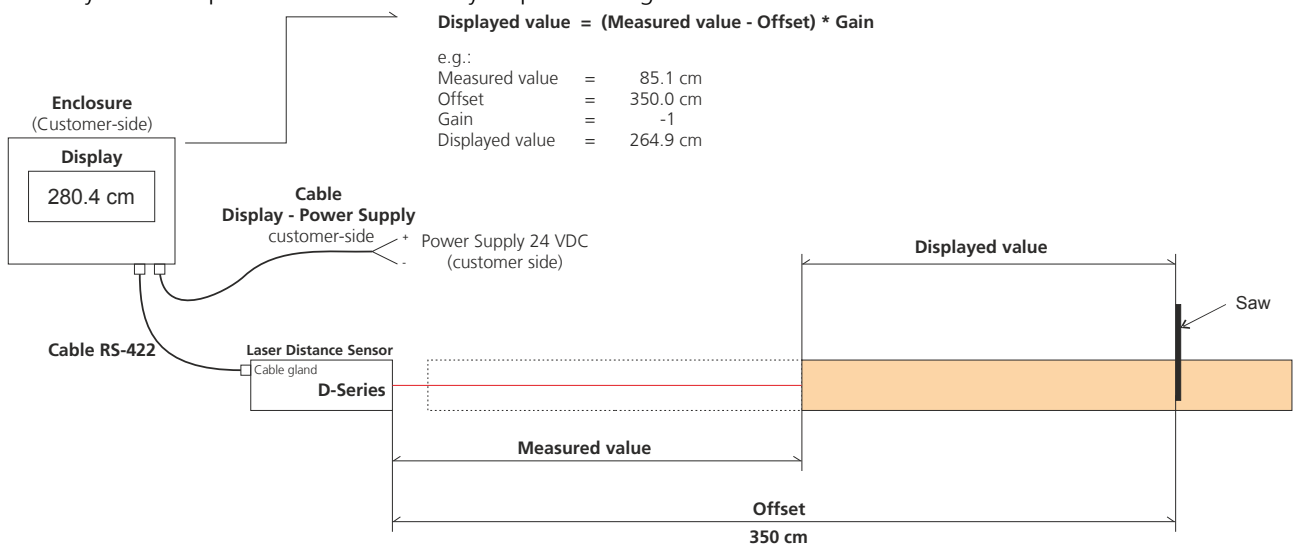

Fig. 3: Overview example 2

## 6.1 Output protocol configuration

This configures the displayed unit and the resolution. In this sample the value is displayed in cm with a resolution of mm. Furthermore it configures the gain and offset for the application.

Do the following steps with the Laser Sensor Utility

1. 'Connection' / 'Check Connection Button'
2. 'Configuration' / 'User output protocol' / Define the displayed value and the resolution

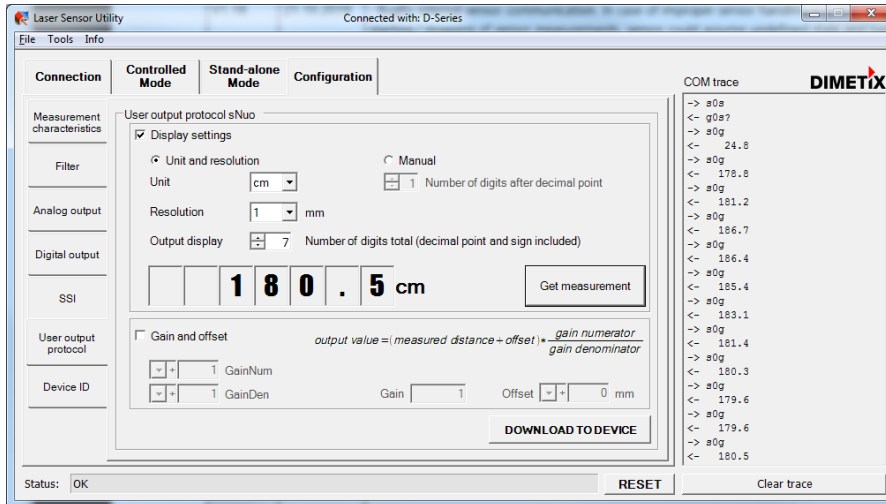

3. Activate the gain and offset check field
4. Configure the offset and gain

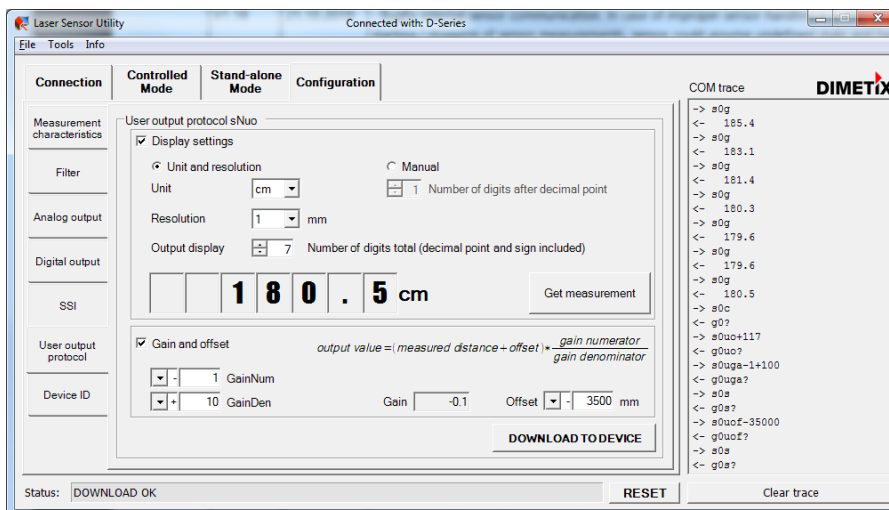

5. Press 'DOWNLOAD TO DEVICE' the configuration is stored into the device

## 6.2 Measurements configuration

There are two different possibilities to start the measurement for this application.

More information in the following chapters:

- 5.2.1 Autostart with serial output
- 5.2.2 Measurement with digital input

